

860575794 | Issue 20190722-July 2019

LED SMARTSENSOR 3M1-W INSTALLATION

GENERAL

The LED smartsensor 3M1-W controls and dims a connected smartengine-ready 3rd party LED fixture, collects data on light levels, temperature and motion, and transmits this environmental data back to the smartengine. The smartengine powers the smartsensor via low voltage cable.

The smartsensor is easily installed in the ceiling tile or junction box near the fixture and accepts standard category 5e, 6 or 6a cable via RJ45 connectors

for fixture and data connections. In addition, the smartsensor can also connect to an electrical light switch with 20 AWG (1mm) wiring via snap-in connectors to enable manual lighting control.

The LED smartsensor 3M1-W must be used with smartengine 3, Model 4834, running 3.1 software or later.

ORDERING INFORMATION IS LISTED BELOW

Part No.	Description
SSEN-1-W-GNEW1350	LED Sensor, one channel 350-499 mA fixture
SSEN-1-W-GNEW1500	LED Sensor, one channel 500-700 mA fixture
SSEN-1-W-OCCU0001	LED Sensor, one channel 150 mA occupancy indicator fixture
SSEN-1-W-SENSOR00	LED Sensor, sensor only



LED SMARTSENSOR 1-W

SMARTSENSOR COMPONENTS AND DIMENSIONS

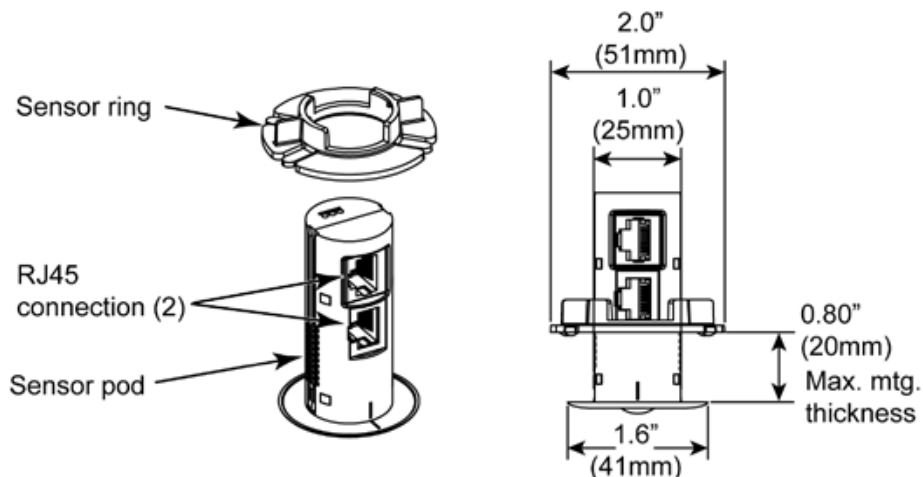

860575794 | Issue 20190722-July 2019

LED SMARTSENSOR 3M1-W INSTALLATION

! IMPORTANT

- Be sure the smartsensor is clear of any other equipment above the tile.
- The plastic smartsensor cap should be tight against the ceiling tile.
- The smartsensor may be rotated inside the ceiling tile hole, but it must remain perpendicular to the tile.
- It is recommended to not place smartsensor near heating vents, AC units, or any other electrically dynamic system.
- The smartsensors have been tested by UL to UL2043 which ensure slow smoke-emitting characteristics and suitable fire resistance for equipment that may be installed in environmental air-handling spaces, as described in Article 300.22(c) of the NEC (2008).
- When the product is installed in air-handling spaces, such as above some suspended ceilings, the cabling employed should be suitable under NEC (2008) Article 800.154 and marked accordingly for use in plenums and air-handling spaces with regard to smoke propagation, such as CMP. The products and wiring should be installed in accordance with all applicable local regulations and practices.

PREPARATION

1. For a lay-in light fixture (2' x 2', 2' x 4', or 600mm x 600mm), smart-sensors should be placed in the ceiling tile adjacent to the fixture.
2. smartsensors should be placed close to the fixture, preferably within 2" (51mm) in order to obtain accurate light level readings and enact daylight harvesting accurately.

For downlights, smartsensors can be placed in the same ceiling tile. Fixtures come with attached RJ45 plugs and wires. The wire length may limit the distance of the smartsensor from the fixture.

Determine where in the ceiling tile the smartsensor needs to be installed; refer to the diagram (Figure 1) on page 3.

NOTE

The motion coverage pattern diagram of the smartsensor is shown below. The diagram illustrates the expected motion sensing coverage for each smart-sensor installed at a ceiling height of 10 feet (3m).

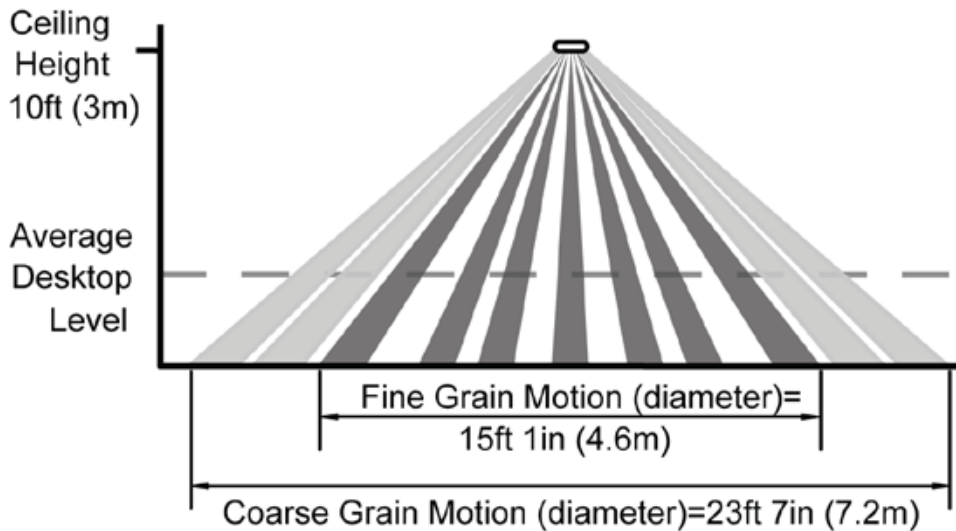

Fine and Coarse Grain Detection Ranges at Ceiling Height of 10 ft. (3m)

860575794 | Issue 20190722-July 2019

LED SMARTSENSOR 3M1-W INSTALLATION

INSTALLATION

1. Within 2" (51mm) of the fixture, drill a 1" (25mm) diameter hole in the ceiling tile.
2. Carefully push the smartsensor through the ceiling tile.
3. Twist and lock the adjusting height sensor ring to tighten the smart-sensor against the tile.
4. Connect the fixture to the smartsensor by way of the white RJ45 jack.
5. Connect the black RJ45 jack from the smartsensor to the smartengine using category cable.

FIGURE 1

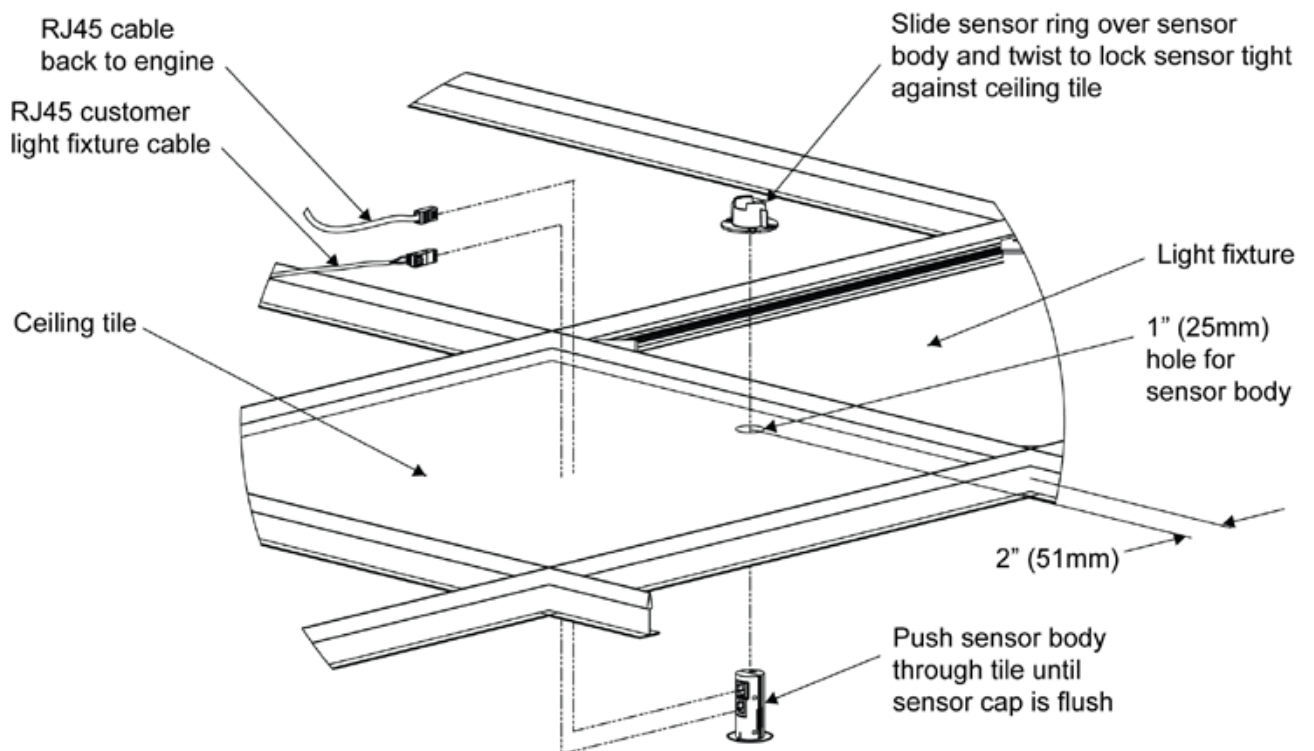

860575794 | Issue 20190722-July 2019

LED SMARTSENSOR 3M1-W INSTALLATION

OPTIONAL STEP – CONNECT SMARTSENSOR TO LIGHT SWITCH

NOTE

The smartsensor may be connected to a single-pole, single-throw (SPST) light switch using 20 AWG (1mm) wire. When connected to an individual smartsensor in a designated room, the switch will control all the light fixtures in that room manually.



IMPORTANT

This is not an option for the smartdimmer or scene control wall smartswitch.

PREPARATION

1. Determine location for the wall switch and associated smartsensor.
2. Run two low-voltage 20 AWG (1mm) cables from smartsensor to wall switch location.

NOTE

It is recommended to use jacketed 20/2 solid core bell wire for this application.

3. Strip 1/4" (6mm) of insulation from the end.
4. Cut or use an existing standard-sized wall plate opening for a NEMA standard, OTS electrical switch box with an open back.

INSTALLATION

1. With the light switch in the ON position, run 20 AWG (1mm) cable from the light switch to Port C on the smartsensor and the remaining end to either Port A or Port B.
2. Install the faceplate on the switch.

HOW TO CONTACT US

To find out more about wtec products, visit us on the web at www.wtec.ag

FOR TECHNICAL ASSISTANCE:

- EMEA, contact your local account representative
- An email can also be sent to smartenginesupport@wtec.ag for technical support.